



BACKCASTING THE GB BALANCING MECHANISM WITH BID3

Pöyry and National Grid joint report

September 2017

BACKCASTING THE GB BALANCING MECHANISM WITH BID3



Contact details

Name	Email	Telephone
Ovidiu Stoica	ovidiu.stoica@poyry.com	+44 1865 812876
Tomas Poffley	tomas.poffley@nationalgrid.com	+44 7779 438521

Pöyry is an international consulting and engineering company. We serve clients globally across the energy and industrial sectors and provide local services in our core markets. We deliver management consulting and engineering services, underpinned by strong project implementation capability and expertise. Our focus sectors are power generation, transmission & distribution, forest industry, chemicals & biorefining, mining & metals, transportation and water. Pöyry employs over 5,000 experts across extensive local office networks. Pöyry's net sales in 2016 were EUR 530 million and the company's shares are quoted on Nasdaq Helsinki (Pöyry PLC: POY1V).

Pöyry Management Consulting provides leading-edge consulting and advisory services covering the whole value chain in energy, forest and bio-based industries. Our energy practice is the leading provider of strategic, commercial, regulatory and policy advice to energy markets in Europe, the Middle East and the Americas. Our energy team of 200 specialists offers unparalleled expertise in the rapidly changing energy sector.

Copyright © 2017 Pöyry Management Consulting (UK) Ltd

All rights reserved

No part of this publication may be reproduced, stored in a retrieval system or transmitted in any form or by any means electronic, mechanical, photocopying, recording or otherwise without the prior written permission of Pöyry Management Consulting (UK) Ltd ("Pöyry").

This report is provided to the legal entity identified on the front cover for its internal use only. This report may not be provided, in whole or in part, to any other party without the prior written permission of an authorised representative of Pöyry. In such circumstances additional fees may be applicable and the other party may be required to enter into either a Release and Non-Reliance Agreement or a Reliance Agreement with Pöyry.

Important

This document contains confidential and commercially sensitive information. Should any requests for disclosure of information contained in this document be received (whether pursuant to; the Freedom of Information Act 2000, the Freedom of Information Act 2003 (Ireland), the Freedom of Information Act 2000 (Northern Ireland), or otherwise), we request that we be notified in writing of the details of such request and that we be consulted and our comments taken into account before any action is taken.

Disclaimer

While Pöyry considers that the information and opinions given in this work are sound, all parties must rely upon their own skill and judgement when making use of it. Pöyry does not make any representation or warranty, expressed or implied, as to the accuracy or completeness of the information contained in this report and assumes no responsibility for the accuracy or completeness of such information. Pöyry will not assume any liability to anyone for any loss or damage arising out of the provision of this report.

TABLE OF CONTENTS

EXECUTIVE SUMMARY	1
1. INTRODUCTION	3
1.1 Context	3
1.2 GB Balancing Mechanism	4
1.3 Objectives and output	4
2. METHODOLOGY	5
3. DISPATCH (DAY-AHEAD MARKET SIMULATION)	7
3.1 Model set-up and assumptions	7
3.2 Model results	11
4. REDISPATCH (BALANCING MECHANISM SIMULATION)	15
4.1 Model set-up and assumptions	15
4.2 Model tuning process and results	16
5. CONCLUSIONS	21
5.1 Lessons learned and further improvement points	21
ANNEX A – DISPATCH AND REDISPATCH IN BID3	23
ANNEX B – PÖYRY INDEPENDENT MARKET REPORTS	27
ANNEX C – DATA SOURCES	29
QUALITY AND DOCUMENT CONTROL	31

[This page is intentionally blank]

EXECUTIVE SUMMARY

National Grid, as the GB System Operator (SO) holds an important role in coordinating the planning of future transmission network investment. As part of this responsibility, a thorough understanding of the costs that will be incurred on the consumer’s behalf in managing and reinforcing the system is indispensable; however, these costs are driven by an electricity market that will continue to undergo rapid and not necessarily predictable change for the foreseeable future.

To facilitate prudent investment decisions, the SO forecasts the future market under a range of scenarios (the Future Energy Scenarios), the network congestion that will arise under each of these with various future network designs, and the cost of managing this congestion (known as constraint cost). This view of credible futures and how different levels of network investment affect constraint costs allow us to manage risk to ensure the GB consumer is not exposed to unnecessary costs, whilst maintaining a secure network for the coming decades.

A key factor in the reliability of National Grid’s forecasts, and thereby the proposed recommendations, is the quality of tools which underpin it. Since 2016, the main modelling platform used by National Grid has been Pöyry’s BID3. As the SO’s view of constraint costs drive such important network investment processes as the Network Options Assessment, Strategic Wider Works Assessments and Connection Infrastructure Options Notes, a high degree of confidence in the model’s outputs is vitally important. National Grid have therefore undertaken a range of assurance activities to ensure that their forecasts are robust and reliable as recommended by an independent audit.

Backcasting, the comparison of modelled outputs to historical outturn values, is a well-established method of testing the performance of models. The SO and Pöyry have worked together to undertake such an exercise with BID3, using the SO’s knowledge and understanding of the Balancing Mechanism and Pöyry’s expertise in BID3 modelling and backcasting. In doing this, it has been shown that by entering historical inputs into BID3, the model can accurately replicate the historical outputs of the Balancing Mechanism such as constraint costs (as shown in Table 1). This shows that while there is inevitable uncertainty in the future of the GB electricity market, BID3 can be trusted to produce outputs that sensibly reflect the real market.

Table 1 – Total constraint costs for 2015

	BID3	Market
Total 2015 constraint costs (£m)	276.85	260.08

[This page is intentionally blank]

1. INTRODUCTION

1.1 Context

In 2016, National Grid SO procured the electricity market model BID3 from Pöyry, with a view to improving constraint cost forecasts above what was achievable with the previous model, ELSI. These forecasts inform the SO's network investment recommendations, which influence the future build of the GB transmission network. The quality of the model is thus important to stakeholders including Ofgem, Transmission Owners, and the GB consumer. The SO is therefore committed to transparency on how this model is used, and providing assurance to all parties that the model is representative of the GB Balancing Mechanism. This purpose of this report is to demonstrate to all parties that the SO's use of BID3 credibly reflects the Balancing Mechanism, and is a sound basis for network investment decisions. This is shown through the results of a backcasting exercise undertaken by Pöyry and the SO during the summer of 2017.

BID3 is an economic dispatch optimisation model. It can simulate all European power markets simultaneously in great detail; it models down to individual power stations, for example. It includes representations of demand, supply and infrastructure, and balances supply and demand on an hourly basis. In modelling the hourly generation of all power stations on the system, it accounts for a range of inputs including fuel prices, historical weather patterns, detailed thermal plant parameters, operational constraints, and other network and market factors that drive costs, prices and flows. A key differentiator to the previous model is the more accurate treatment of the dynamic relationship between GB and other markets over the wide range of interconnectors expected to connect to GB in the 2020s. A strong understanding of the behaviour of these interconnectors, underpinned in part by BID3 modelling, will prove important to sound network investment.

This backcasting exercise completes a range of activities undertaken as part of the assurance process for the new model.

“As National Grid implements this new model it will be inherently introducing a number of new variables into its economic analysis, by virtue of the sophistication of BID3 above the current modelling tool ELSI. Furthermore, the introduction of the model moves National Grid away from open source modelling achieved through ELSI (MS Excel VBA based linear programme) to one which utilised commercial grade optimisers and external consultants to configure. Ofgem thus expect National Grid to naturally provide them with a series of assurance that the model is configured in the most appropriate way to meet the analysis purpose. The measures proposed to provide these assurances include:

- *Benchmark exercise of BID3 against ELSI for a number of future years across alternative future energy scenarios for 2015¹.*
- *Demonstration of an external independent review and QA of the model.*
- *Backcasting the model performance against historical market outturn.”*

The satisfactory completion of the three activities listed has given the SO every confidence in the outputs of BID3.

In addition to the assurance aspect of backcasting, exercises of this nature help National Grid better understand the relationship between modelled outputs and the real world.

¹ [National Grid SO - Long-term market and constraint cost modelling](#)

This grants the opportunity to improve the SO's modelling and insights, and thereby better manage the risks to the GB consumer of over or under investment.

1.2 GB Balancing Mechanism

The CBA philosophy of the SO's Economics Assessments Team has in recent years depended on a forecast of 'constraint costs'; this refers to Electricity National Control Centre (ENCC) spend in the Balancing Mechanism (the market of last resort) to alleviate network congestion caused by market driven flows. The network congestion could alternatively be alleviated by increasing the transfer capacity of the network via reinforcements (which has an associated capital spend); this is the central trade-off that underpins many of the investment recommendations made by the SO. The SO procures many types of reserve and response, as well as alleviating network issues driven by phenomena other than excessive flows. An important distinction for this backcasting exercise is therefore to make clear that we are primarily concerned with the costs relevant to BID3 modelling. Only a subset of the ENCC spend (constraint costs) is comparable to the costs BID3's redispatch module captures.

All 2015 historical constraint cost results used as metrics in this report have been obtained from National Grid's Monthly Balancing Service Summary reports². The results within this report allow us to compare BID3's performance in modelling the BM in three key areas:

- Annual direct constraint costs (constraint costs arising from moving generation positions due to boundary constraints), and costs related to plant needed for overnight voltage control;
- Constraint cost allocation by generation type; and
- Total constraint costs by month.

1.3 Objectives and output

The main objective of this exercise is to demonstrate the model is a fair representation of the GB Balancing Mechanism (BM).

Due to a number of factors that are not accounted for in the modelling (random faults, National Grid's pre-gate closure trading function, wind & demand forecast error, spends due to other types of constraints which are hard to separate), the SO does not expect perfect replication of the ENCC actions with great precision on an hourly basis; however, over the course of a year, annual constraint costs from BID3 are expected to fall close to the true value.

Further to demonstrating the credibility of the model, this report intends to outline the reasons for differences between modelled and real spend.

² <http://www2.nationalgrid.com/UK/Industry-information/Electricity-transmission-operational-data/Report-explorer/Services-Reports/>

2. METHODOLOGY

In order to achieve the main goal of this report (to reinforce the suitability of BID3 for GB constraint cost forecasting), it was decided that a whole calendar year should be backcast to capture the behaviour of the model across all seasons. 2015 was chosen as the year to replicate for this exercise as it was the most recent year for which all data was available needed to model the GB electricity market on an hourly basis. A full list of these data sources is available in Appendix C.

BID3 calculates constraint costs in a two-step process. Firstly, a full market dispatch (based on minimising total system costs to which plants contribute through their short run marginal costs) is performed, ignoring network transfer restrictions. This resembles the day-ahead market clearing algorithm and sets hourly generator positions prior to any balancing actions dictated by the SO. Secondly, the redispatch module is run - this brings in additional constraints concerning boundary transfer capabilities. Briefly, the concept of boundary describes a line separating the network in two, where flows of electricity from one side of the boundary to the other are constrained by its capability. The aim of the redispatch module is to minimise the total cost of balancing actions while respecting boundary transfer and plant dynamics constraints.

To calculate the total costs that arise from GB transmission network constraints, it is necessary to compare costs in the presence of boundaries against those without boundaries. The approach BID3 is using is to re-optimize plants based on their short run marginal costs of generation plus an offer-on or bid-off value at an individual plant level (more specifically, the objective will be to minimise short run marginal costs adjusted by the bid-offer spread while adhering to boundary constraints). A full description of how this is performed in BID3 is available in Annex A.

Purely demonstrating BID3's capability of back-calculating total constraint costs could be done by fixing the generating position of power plants at the day-ahead Final Physical Notification. However, considering that in all the forecasting done by National Grid both the dispatch and redispatch modules are used, we have also included the dispatch stage in the backcast. Proving that BID3 can closely replicate market results both at a dispatch and redispatch stage strongly strengthens its suitability as National Grid's core modelling platform.

[This page is intentionally blank]

3. DISPATCH (DAY-AHEAD MARKET SIMULATION)

The first step of the backcasting exercise was attesting that BID3 can reproduce with high accuracy day-ahead market results based on the 2015 set of inputs. Two main metrics have been used to assess BID3's performance at this stage of the backcast:

- Day-ahead wholesale electricity prices; and
- The generation positions power plants have ahead of any balancing actions undertaken by the SO (these are directly comparable to the power plants' Final Physical Notification (FPN) reported by ELEXON).

BID3 consists of two elements in its formation of the wholesale electricity price – firstly a System Marginal Price (SMP), which represents the cost of generation for meeting an extra unit of demand and secondly a Scarcity Rent element, which represents a plant's ability of bidding above their short-run marginal costs in situations of system tightness. For the purpose of the backcast, we have not included the Scarcity Rent element in the wholesale price, as from a model point of view scarcity pricing does not influence plants' behaviour in the balancing mechanism (bid-off and offer-on are a function of short run marginal costs).

3.1 Model set-up and assumptions

Backcasting the day-ahead market required the implementation of different assumptions and a specific model set-up. These are encompassing five main areas:

- Regional configuration of the GB market;
- Power plants;
- Demand;
- Interconnection; and
- Fuel prices.

3.1.1 Regional configuration of the GB market

The backcast process, both on the dispatch and the redispatch stages has been done by modelling GB in isolation – the interconnector flows to neighbouring markets having been fixed on an hourly basis. This ensures we can calibrate the GB balancing mechanism within BID3 in isolation and remove the complexity of cross-border trading over interconnectors. While interconnector trading is likely to play a large part in the balancing mechanism by the late 2020s, given we are only looking at 2015 the omission of this aspect will have little effect on this exercise. likely Furthermore, GB has been represented in BID3 as 29 price areas³ in order to ensure all generation falls on the correct side of major boundaries considered in this exercise. 25 GB transmission boundaries were considered in this exercise, each with a unique daily transfer capability profile. During the dispatch stage, the boundary transfer capabilities are not binding (as much electricity as needed can be transferred between price areas) – the result will hence be an identical wholesale electricity price for all the price areas.

³ In BID3, a price area represents a geographical region having the same electricity price (the model is optimising the generation and imports/exports of a price area to ensure its demand is met on an hourly basis). A more detailed description can be found in the Appendix A.

3.1.2 Power plants

All the thermal generator capacities and efficiencies used in BID3 are on a net basis (this ensures that no self-consumption is considered). Major thermal generation units (CCGT, coal and nuclear plants) have been assigned daily availability profiles based on ELEXON data to better reflect unit-specific outages especially at the redispatch level. Additionally, mid-year plant commissioning/decommissioning has been accounted for, this being a particularly important aspect for renewable generators (2015 being a year with considerable renewable capacity uptake).

The thermal plants technical characteristics such as efficiencies, start-up and no-load costs have been kept to the default values from the dataset Pöyry has provided to National Grid, in order to avoid excessive plant individualisation.

Wind and solar contribution has been driven by the generation profiles National Grid has been provided with by Pöyry. Wind and solar profiles are based on historical wind speed and irradiance time series reanalysis; a detailed description of the methodology behind these profiles can be found in Annex A. Figure 1 shows the geographical granularity of wind/solar profiles used in the backcast.

Figure 1 – BID3 wind and solar profiles

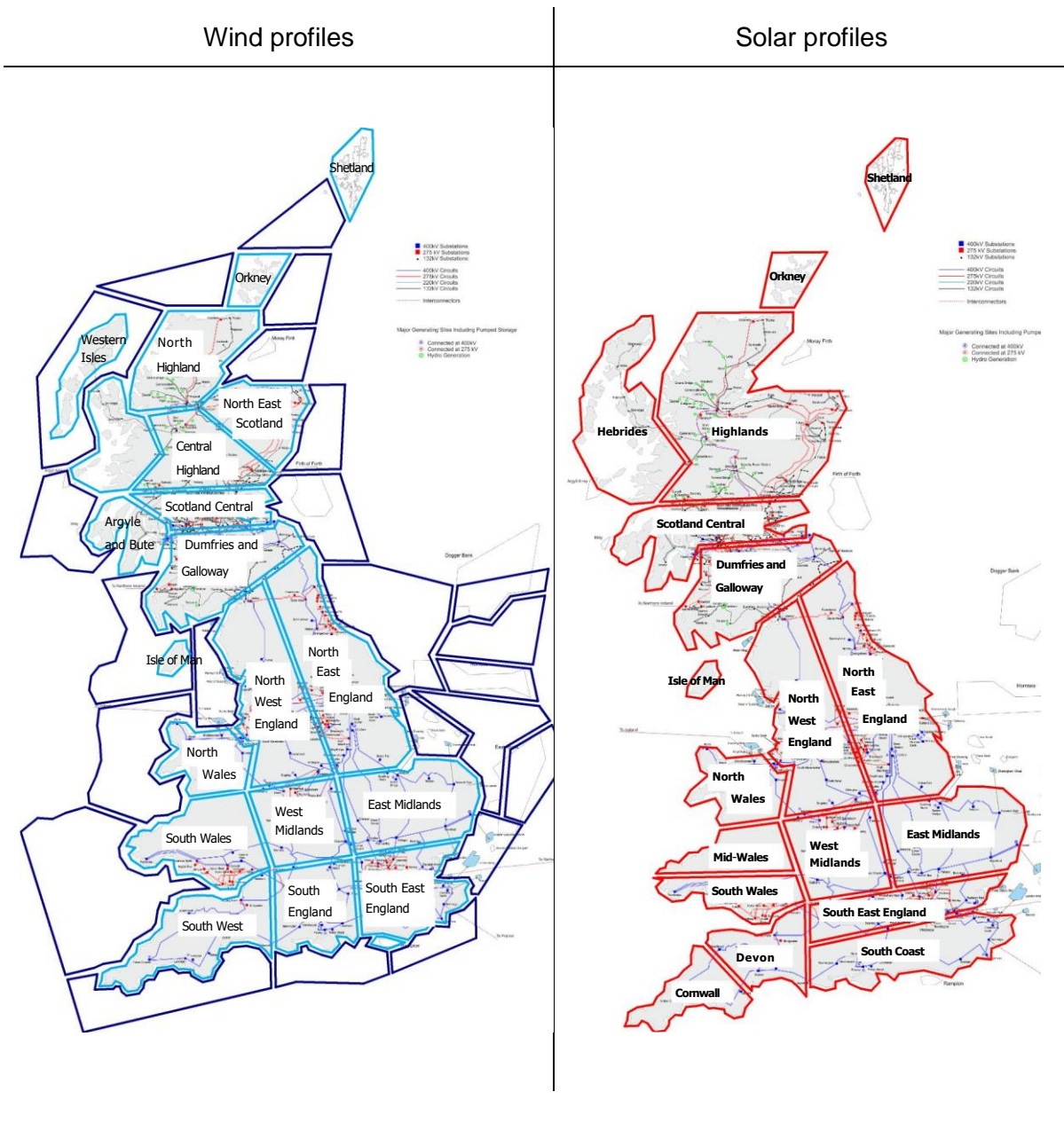

Despite National Grid using embedded and transmission level generation in forecasting projects such as the Future Energy Scenarios and the Network Options Assessment, the dispatch stage of the backcast has initially envisaged modelling only the transmission level generation to avoid any issues caused by embedded-level generation data availability. However, embedded generation does play an important role in the redispatch phase; as demand and embedded generation are not equally split around GB, the import/export regional capabilities and hence redispatch costs are heavily influenced by these factors. Consequently, the England-Wales and Scotland demand profiles had to include wind and solar embedded generation, as well as these sources having had to be

included in the generation side. The regional allocation of monthly installed capacities for embedded wind and solar has been provided by National Grid⁴.

3.1.3 Demand

Splitting the GB 2015 total demand between the 29 price areas (11 of these being in Scotland and 18 in England and Wales) has been done based on a winter peak methodology. Due to limitations in the availability of locational demand data, the split of demand by Grid Supply Point at Winter Peak is assumed to be the same across the whole year. This is the same methodology used for modelling of future years.

BID3 splits the demand on an hourly basis using profiles – considering that during the dispatch stage a national-level profile will suffice, we have initially made use of the data published by National Grid, as the National Demand figure, which represents the sum of transmission-level metered generation, but excludes generation required to meet station load, pump storage pumping and interconnector exports (this being consistent with the way power plant capacities and efficiencies are utilised in BID3). As previously stated, the need of including embedded generation in the modelling process also involved the inclusion of this generation on the demand side (essentially, at the dispatch stage this is cancelled out and only influencing the redispatch).

Considering that the main aim of the exercise was to reproduce the total constraint cost, an individualised demand profile for each price area would have been helpful. This would have enabled a clear differentiation between price areas encompassing area with a low population density and highly populated and industrialised metropolitan areas. Unfortunately, data availability proved to be a hurdle in this respect, the only regional split available being a Scotland one. We have therefore used only two hourly profiles for the Scottish and the English-Welsh price areas, expecting that the redispatch will be impacted by this.

3.1.4 Interconnection

As stated in 3.1.1, the interconnector flows to the neighbouring markets have been fixed on an hourly basis to the metered flows reported by National Grid³. Although offering numerous advantages, we have anticipated this option causing an underestimation of the low prices (usually set by interconnectors) in the day-ahead market backcast.

3.1.5 Fuel prices

The backcast made use of hub-level fuel prices (fuel prices at their source prior to transportation costs), to which daily/monthly variation profiles have been assigned. A summary of the most important includes:

- Gas – National Balancing Point price, with a daily resolution;
- Coal – ARA hub price, with a monthly resolution; and
- Carbon – Carbon Floor Price, with a monthly resolution.

Fuel prices incurred by power stations have been further individualised by using plant-specific fuel transportation costs as specified by National Grid⁵.

⁴ <http://www2.nationalgrid.com/UK/Industry-information/Electricity-transmission-operational-data/Data-Explorer/>

Additionally, to better reflect the costs incurred by generators, the Balancing Services Use of System (BSUoS) has been included on an hourly basis.

3.2 Model results

Backcasting the day-ahead market has been done through an iterative process, through which plant-specific technical parameters (efficiencies and/or variable other works costs⁶) have been finely tuned. Ahead of the redispatch phase, it had to be ensured that plants such as Longannet (which was utilised heavily in the 2015 BM) had their FPN position as close to historic data as possible to test whether BID3 could replicate this historic behaviour.

The dispatch-level results showed that BID3 can replicate generation patterns and wholesale prices with a very high level of accuracy (a price-duration curve can be seen in Figure 2 and the annual levels of Final Physical Notifications by fuel type in Figure 3). On a purely time weighted average basis BID3 can replicate wholesale prices with 0.5% level of accuracy (shown in Table 2). On an hourly basis, BID3 achieves a 15% average absolute difference.

Table 2 – Total constraint costs for 2015

	BID3	Market
Time weighted average of wholesale prices (£/MWh, real 2015)	40.28	40.45

⁵ <http://www2.nationalgrid.com/UK/Industry-information/System-charges/Gas-transmission/Charging-Statements/>

⁶ Variable other works costs (VOWC) are used in BID3 to describes costs other than fuel and carbon incurred by generators on a per MWh basis.

Figure 2 – 2015 price duration curve

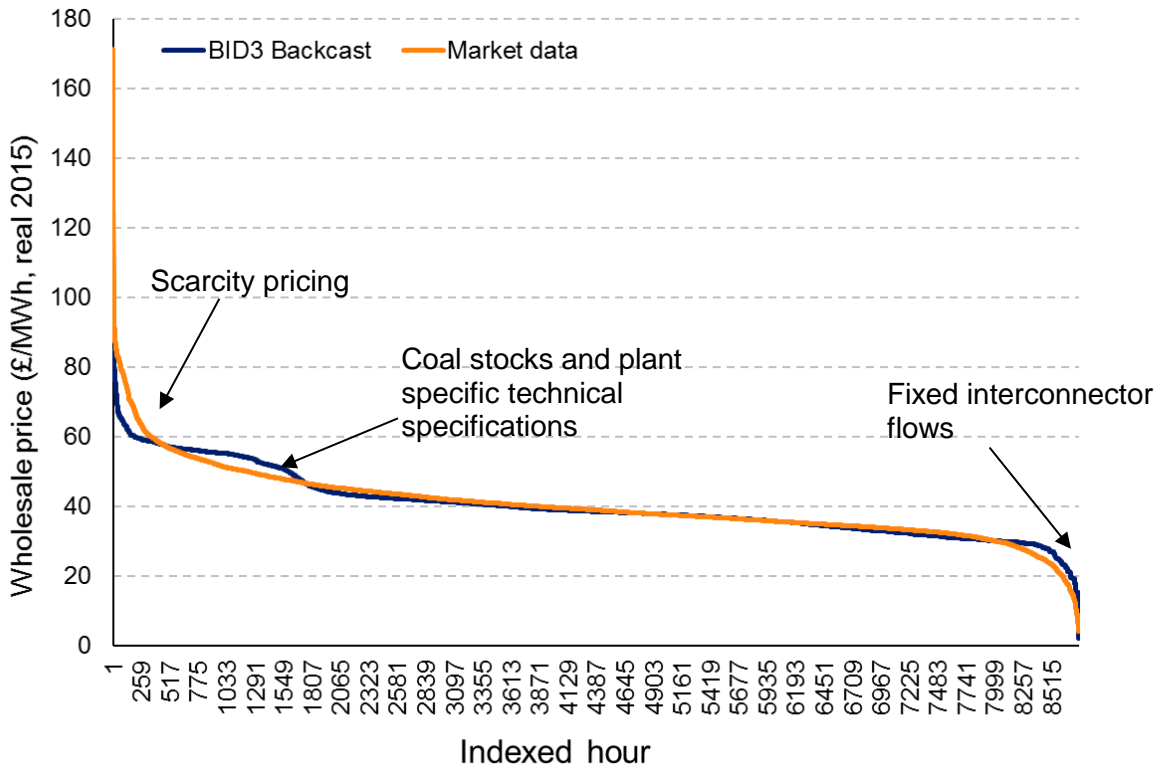
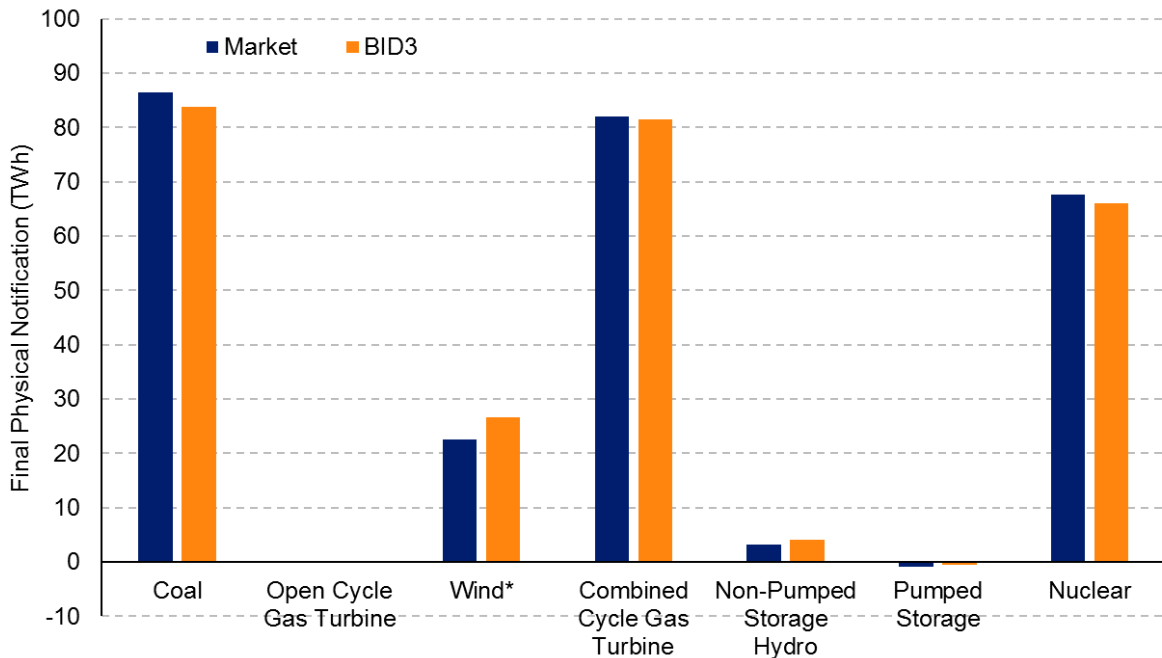

Figure 3 – Final Physical Notification (FPN) volumes



*BID3 data includes embedded wind, Market includes only Elexon BM units

Based on the price-duration curve, although BID3 matches very closely more than 75% of the prices, some expected differences do appear at the extremities of the curve. The top 5% hours of 2015 do show signs of scarcity pricing in the GB system (as stated in section 3, scarcity pricing has been purposely excluded from the scope).

The price differences further arise from actions not directly related to fundamentals of supply and demand. 2015 was a year with multiple coal plants either decommissioning or preparing for the Industrial Emissions Directive (IED) compliance. This implies that any stocks of coal (be it coal remaining on the plant's stock ahead of decommissioning or coal with a high sulphur content) had to be utilised. This has a distorting effect on the short run marginal cost bidding approach, since these plants are essentially bidding less than their SRMC. This is justifying both the difference in FPN level coal generation, as well as BID3 overestimating some of the high prices – as coal plants are generating more than economically viable, expensive generators (CCGTs or OCGTs) are pushed out of the supply curve. Furthermore, it has been observed that BID3 creates a blockier supply curve, given that power plants are not individualised in terms of technical parameters.

Additionally, differences in prices and generation are also expected given the plants' positioning for providing frequency response. It has been noticed that thermal and pumped storage plants tend to generate at the minimum stable generation limit to provide reserve. An immediate effect of this would be that fewer start costs would be feeding into the wholesale price (a plant having a frequency response contract and running at MSG can easily increase its output to meet peaks in demand; conversely dispatching the plants purely on their short run marginal costs will have as an effect numerous cold starts to meet the peaks).

Not surprisingly, the effect of fixing the interconnector flows mentioned in the Interconnection section can be observed on the right-hand side of the price-duration curve.

[This page is intentionally blank]

4. REDISPATCH (BALANCING MECHANISM SIMULATION)

The two main input areas of interest for the redispatch process included:

- Zonal distribution of boundaries and their capabilities; and
- Power plant bids and offers.

4.1 Model set-up and assumptions

4.1.1 Boundaries

A major component in calculating redispatch costs is setting boundary transfer capability on a daily basis. As a starting point for the backcasting exercise, the 2015 year-ahead transmission outage plan was used to assign daily boundary capabilities in BID3. While this plan will not mirror the exact 2015 boundary capabilities due to within year rescheduling, it was considered to suffice as major outages driving most constraint costs should be captured.

Figure 4 – An example boundary in the south west region of GB

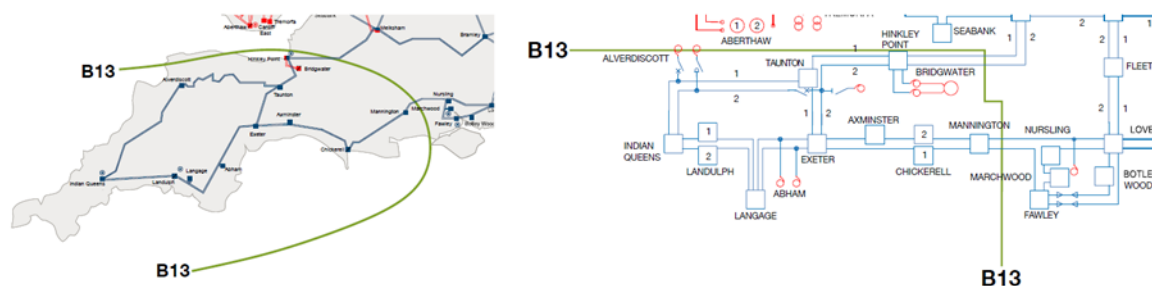

4.1.2 Power plant bids and offers

All power plants in BID3 are assigned a bid and offer ‘multiplier’ or ‘adder’ in order to set a price should the redispatch module decide to adjust a generator’s position.

$$\text{Redispatch Price } (\text{£/MWh}) = \text{SRMC } (\text{£/MWh}) * \text{Bid/Offer multiplier}$$

OR

$$\text{Redispatch Price } (\text{£/MWh}) = \text{SRMC } (\text{£/MWh}) + \text{Bid/Offer adder}$$

Typically, a bid/offer multiplier is used for thermal plant types as these tend to base their bids and offers on their SRMC. Adders are reserved for renewable plant types as the value of their lost subsidies needs to be accounted for.

The values for bid/offer multipliers and adders in this exercise have been based off historical data from within National Grid’s Network Economic Database (NED). To reflect the methodology used for future constraint forecasting in the SO, these multipliers and adders are generalised by plant type instead of being tailored to each individual plant.

4.1.3 Additional constraints

A further consideration in the backcasting exercise was to capture BM costs arising due to voltage constraints. These costs materialise due to the SO having to ensure thermal generators which can provide voltage support are generating overnight when voltage problems tend to occur on the system. If these plants are not dispatched in the market, the SO has to intervene and incur a cost for turning these generators on. This behaviour has been implemented in BID3 using the co-optimisation of energy and reserve holding (voltage constraints being implemented as reserve constraints to which power plants can contribute even if not part loaded).

4.2 Model tuning process and results

The first redispatch iteration run with BID3 prompted total constraint costs significantly higher than the historical values. The BID3 dataset tuning process involved an iterative approach aiming to isolate and further investigate boundaries where there were heavily redispatched power plants: our analysis had consequently focused on boundary capabilities and outage patterns.

Although a rather limiting assumption, the use of year-ahead boundary outage patterns was preferred, as the constraint cost forecasting done by the SO solely relies on a perfect foresight of planned outages. Deviation from the Year Ahead plan is often triggered by unavoidable and unpredictable circumstances such as line faults. Modelling these for future years as a flat boundary capability reduction during the main annual outage window is sensible, but the modelling here highlights the importance of a reasonable outage forecast, as outages are a large source of congestion. Year-ahead capabilities have been seen to overestimate the length of boundary outages. Further to this, outage plans change within year to mitigate potential problems on the network. This is highlighted by the fact that within the first iteration, BID3 reported 200 hours of lost load in the Southwest of England due to outages on transmission assets in the area and generator maintenance on Langage CCGT. As no blackouts occurred in the Southwest region during 2015, it is assumed that this outage was rescheduled to avoid loss load and as such, the year ahead boundary capabilities within BID3 had to be adjusted to enable electricity imports for this zone and hence the lost loss issue be alleviated. This represented a first indication that by using year-ahead boundary capabilities, we are not accounting for real-time decisions the SO can take to alleviate security of supply issues.

Constraint costs have been further assessed on a boundary-specific basis, by investigating each individual boundary's contribution to the total constraint cost. A theoretical calculation of the boundary capability has been carried to identify periods when a boundary was over-constraining the exports. Specifically, for all the plants on the exporting side of a boundary, we have assessed the hourly Period Expected Metered Volume reported by ELEXON. This measure is reported on a half-hourly basis and represents the sum of the Final Physical Notification and balancing action volumes (therefore a plant should be able to export that specific energy to the grid during a settlement period). Summing this for each settlement period with the embedded generation and subtracting the demand gives the theoretical boundary capability.

Theoretical Boundary Capability=Period Expected Metered Volume+Embedded Generation-Demand

An example is shown in Figure 5 – the boundary illustrated in the chart shows a clear pattern of capability under-estimation during the first half of 2015. Through an iterative process, we have adjusted constraining boundaries to their theoretical capability, reflecting therefore any actions the SO can take in real time to alleviate system constraints

and ensure security of supply. The adjustments have been done for specific periods of system stress, as we aimed to stick as closely as possible to the original year-ahead outage plans.

Figure 5 – Theoretical and year-ahead boundary capability

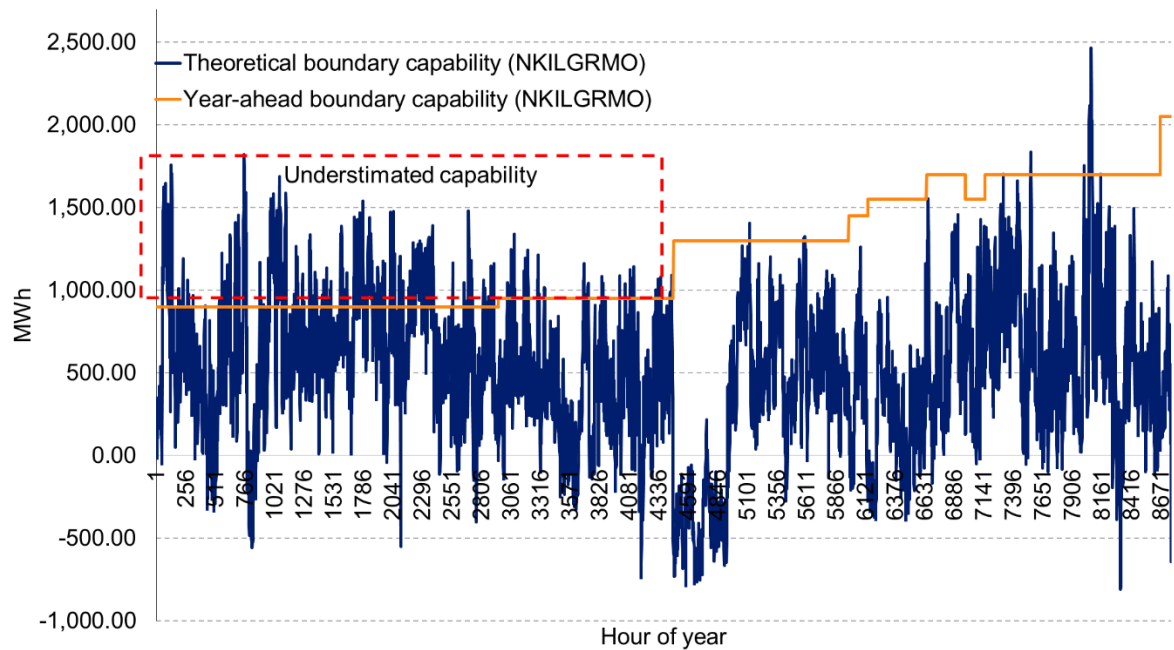

The iterations carried on boundary capabilities have demonstrated that the total constraint cost calculated by BID3 is remarkably close to the historical value; as shown in Figure 6, the difference in constraint costs between BID3 and the historical value is less than 6% (a BID3 result of £276.85mn vs. historic £260.08mn).

Figure 6 – Constraint costs

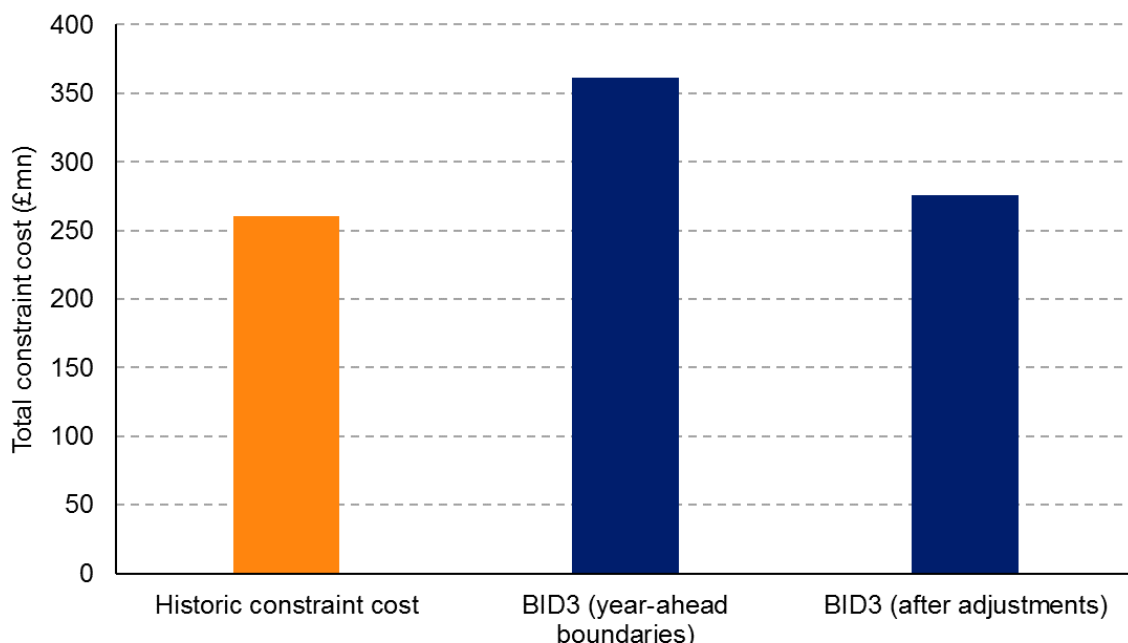

The availability of constraint costs by fuel type only enabled the utilisation of a percentage split, rather than an absolute cost, as historical data includes actions other than constraint mitigation in the split by fuel type. Figure 7 shows using this metric, the contribution of different power plant types to the total constraint cost is accurately modelled by BID3 in the current context of modelling methodology and data assumptions. The differences arising in the case of coal and interconnection swap in reducing the total constraint cost (the SO ultimately saving money by bidding them off) is as a result of the explicit exclusion of interconnectors from the modelling exercise. BID3 uses coal plants to mitigate constraints in the absence of interconnectors, as from a system point of view, these plants represent the minimum cost action.

The analysis done on the data available on the ELEXON platform revealed a total of 1.26TWh of wind curtailment during 2015. Considering that 2015 did not experience any negative electricity prices, it has been assumed that the entirety of this volume corresponds to SO constraint mitigation actions. The BID3 backcast gives 1.2TWh of wind redispatch, which is a very close match to the ELEXON data, and this gives good confidence in both the hourly generation profiles and the allocation by zone.

Figure 7 – Constraint cost by fuel

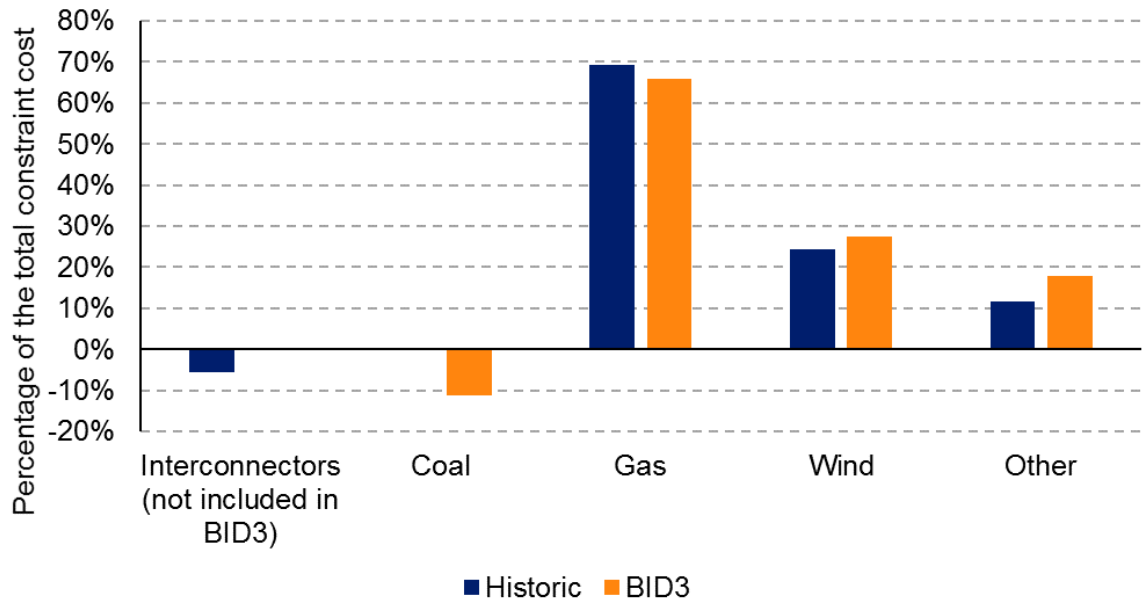
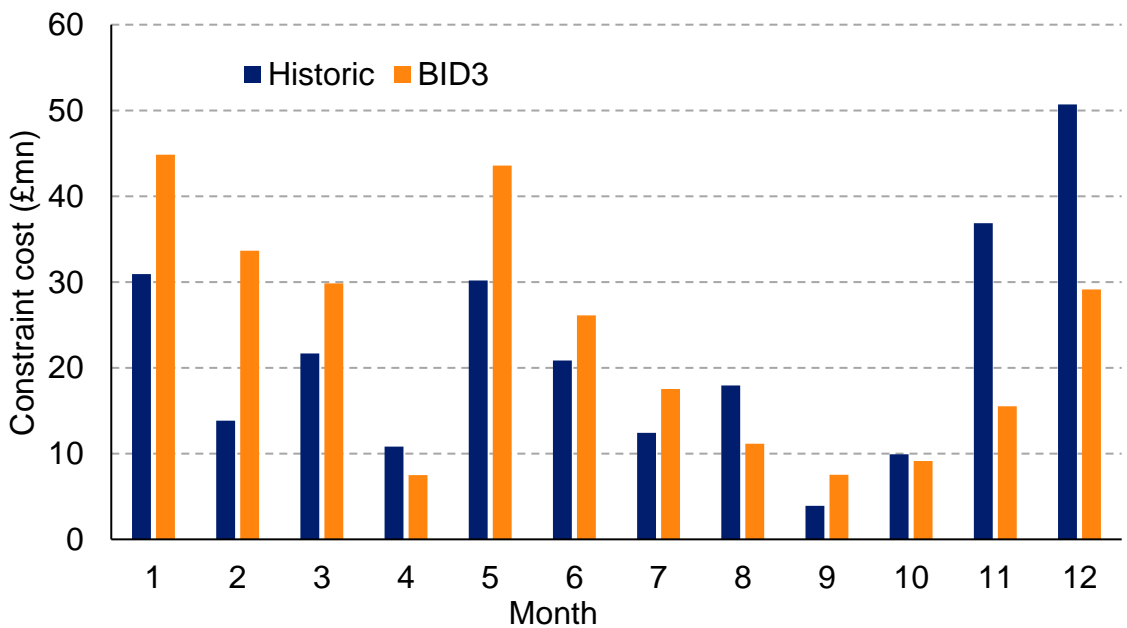

Figure 8 – Monthly redispatch cost



On a monthly basis, the backcast shows that the main trend is captured, however month-on-month cost levels are especially different towards the end of the year. The main driver for this is believed to be rescheduling of outages in the 2015 year ahead plan and thus, boundary capability profiles that deviate from 2015 actuals.

[This page is intentionally blank]

5. CONCLUSIONS

The backcast aimed to confirm both the suitability of BID3 as the main modelling platform used by the SO as well as of the methodologies employed by the SO in the constraint forecasting projects. BID3 replicated day-ahead wholesale electricity prices within 5% of the time-weighted annual average value, and total constraint costs arisen from redispatch were replicated within 6% of the historical value. The two-step approach used in the backcast further increases the SO's confidence in BID3 as the state-of-the-art power market modelling platform considering that the highly accurate redispatch results have been obtained using the results of the dispatch model as a starting point, rather than outturn values. The accuracy of the results should be considered bearing in mind the simplifying assumptions of the backcast exercise; explicitly:

- GB has been modelled in isolation, interconnector flows being fixed and therefore no SO actions could be taken on these in the redispatch phase.
- Day-ahead prices have been modelled on a System Marginal Price only basis – plants bidding only their short run marginal cost in the day-ahead market.
- Demand representation has been limited to the usage of only two regional profiles given the lack of historical data.
- Fuel prices used were hub prices and did not consider any stocks of coal for example.
- All generators of a particular technology have been priced in identically in the balancing mechanism.
- No bilateral contracts have been modelled.

Given the above and the successful implementation of voltage constraint modelling in BID3, the backcast is considered by National Grid to be a success. The slight overestimation of constraint costs falls in line with expectation due to the limitations listed above. National Grid's long-term forecasting methodology includes interconnector redispatch which is assumed to reduce the annual constraint cost forecasting value due to more options being available. Full details on this methodology can be found in National Grid's long-term constraint forecasting report⁷.

5.1 Lessons learned and further improvement points

Both National Grid and Pöyry consider this backcast exercise to be a success. While similar backcasts have been done in the past by Pöyry on market dispatches, this report details the first exercise performed on BID3's recently developed redispatch module. Not only has BID3 been validated as an excellent model for forecasting future constraint costs, but a number of valuable lessons have been also drawn to improve both Pöyry's model development methodology and National Grid's way of utilising BID3:

- **Outages** play a decisive role in accurately modelling constraint costs. Assigning outage profiles to power plants, interconnectors and boundaries when modelling future energy scenarios must ensure that a wide span of plausible outcomes is covered. Furthermore, outages must be assigned consistently, since any mismatches can further affect the model's results.

⁷ [National Grid SO - Long-term market and constraint cost modelling](#)

- **Demand** regional allocation and hourly profiling should be looked at in detail, as different zones have significantly different demand shapes. BID3 offers a high degree of flexibility in splitting demand by sector, assigning different within-year shapes and even optimising flexibility. The uptake of electric vehicles should also be thoroughly considered, as the balancing mechanism can be positively/negatively impacted by flexible demand.
- **Hydro generation** should also be closely considered especially around the dispatchable and non-dispatchable split of reservoirs and their inflows. From a methodological point of view, there is scope to reassess the way BID3 is scheduling water utilisation, as it has been seen that in the redispatch, fixing start and end of week reservoir levels can lead to an under optimal solution due to an artificially reduced flexibility.
- The uptake in **embedded generation** should also be carefully considered, as it can create redispatch issues in other parts of the GB system other than the traditionally constrained zones.
- Future modelling should carefully consider **reserve requirements**, as these have a significant impact on power plants' running patterns.
- Utilising **scarcity pricing** should be further analysed in the forecasting done by the SO, as this will both improve the results of backcasting exercises and guarantee the internal consistency of future capacity expansion scenario modelling.

ANNEX A – DISPATCH AND REDISPATCH IN BID3

The framework used by National Grid to understand and analyse transmission congestion in GB uses the concept of a “Boundary”. A Boundary is a line separating the network in two where flows of electricity from one side of that Boundary to the other are constrained by the Boundary’s capability.

Allocating the Zones to the exporting or importing side of the Boundary is done via a grid similar to that shown in the figure below. An E (or similar) is entered for Zones on the exporting side of a Boundary and an I (or similar) is entered for Zones on the importing side. The Zone is left blank if it should not be included within the constraint. Flows with such zones will then only be constrained by interconnector capacity (the existing way of modelling transmission constraints in BID3).

Figure 9 – Boundaries in BID3

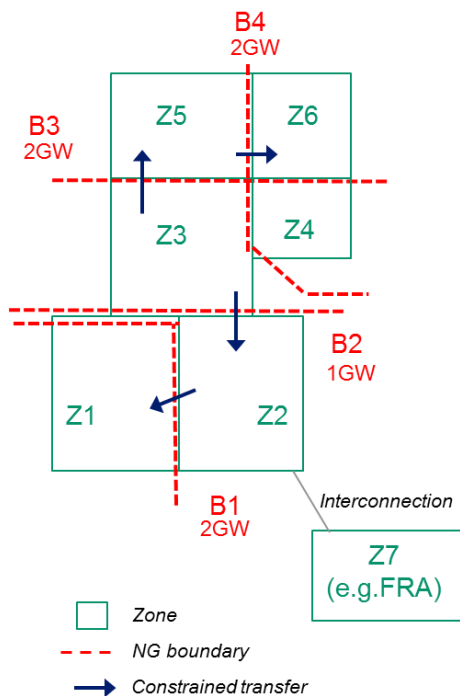

	B1	B2	B3	B4
Z1	I	I	E	E
Z2	E	I	E	E
Z3	E	E	E	E
Z4	E	E	E	I
Z5	E	E	I	E
Z6	E	E	I	I
Z7 (FRA)				

E = Exporting side
I = Importing side
Blank = Ignored

Almost all data in BID3 is entered on a zonal basis. Before the optimisation is run, zonal level data is aggregated to the Price Area level based on the zones allocated to each Price Area by the user. All zones within a Price Area are invisible to the solver – the Price Area is effectively a ‘copper plate’. Only interconnection between Price Areas is visible to the solver. When doing a run in the presence of boundaries the model will first aggregate zones to Price Areas. It will then need to decide which side of each boundary a Price Area is on. This is summarised in the diagram below.

Figure 10 – Boundaries and price areas

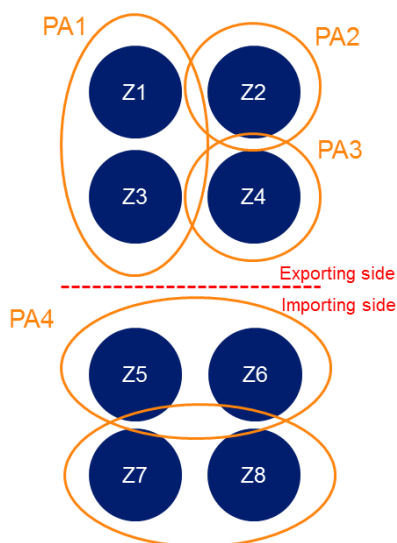

The introduction of GB transmission boundaries into BID3 results in additional constraints being applied in the optimisation, which are summarised in the equations below:

$$\text{Balance (exp. side)} + \text{Balance (imp. side)} = 0 \quad \text{Eq. 1}$$

$$-\text{Balance (imp. side)} \leq \text{Final Boundary capability} \quad \text{Eq. 2}$$

where:

$$\text{Balance} = \text{Generation} + \text{Imports} - \text{Demand} - \text{Exports} \quad \text{Eq. 3}$$

and “Imports” and “Exports” mean flows occurring on interconnectors with other countries not listed as being ‘exporting’ or ‘importing’ Zones.

The model will select the optimal dispatch of plants and flows across boundaries considering all boundaries simultaneously. For example, due to very cheap plants in one of the Zones on the exporting side of a Boundary the model would like to run them fully and create a very high “Balance” on the exporting side. However, it may be prevented from doing this if the Final Boundary capability is too low.

In order to calculate the total costs that arise as a result of GB transmission network constraints, it is necessary to compare costs in the presence of boundaries (henceforth referred to as re-dispatch) against those without boundaries (referred to as dispatch). This requires a re-dispatch of plant within the model, and there is more than one basis on which this could be done.

The approach to re-dispatch is to re-optimize plants based on their short run marginal cost (SRMC) of generation plus an offer-on or bid-off value at an individual plant level (i.e. the objective function will be seeking to minimise SRMC adjusted by the bid-offer spread). The unconstrained market schedule (‘the Dispatch’) will use SRMC to dispatch plant. For Re-dispatch, however, BID3 will only price the change in generation (or flow) from the dispatch.

For most plants (with positive SRMC), a decrease in output should result in a payment from the generator to NG (a ‘saving’), reducing the total constraint costs. Similarly, an

increase in output will result in a payment from NG to the generator (a 'cost'), increasing the total constraint costs. It is the function 'total constraint costs' that BID3 will be trying to minimise in each hour. This is summarised in the equations below.

- Cost to NG of increasing output = Increase in output * Offer price
- Saving to NG for decreasing output = Decrease in output * Bid price

The bid multipliers / adders are used to work out what 'Offer price' and 'Bid price' should be used for each plant. They state how the SRMC of the plant should be adjusted to come up with the price. The equations below show how Offer price and Bid price will be calculated, depending on whether multipliers or adders are entered:

- Using Offer multiplier (%):
 - Offer price = $SRMC + |SRMC| * Offer \% multiplier * Profile$
- Using Bid % multiplier (%):
 - Bid price = $SRMC + |SRMC| * Bid \% multiplier * Profile$
- Using Offer absolute adder (€/MWh):
 - Offer price = $SRMC + Offer\ absolute\ adder * Profile$
- Using Bid absolute adder (€/MWh):
 - Bid price = $SRMC + Bid\ absolute\ adder * Profile$

Typically, Offer multipliers and adders will be positive (reflecting the fact that increasing output normally costs more than SRMC) while Bid multipliers and adders will be negative (reflecting the fact that decreasing output normally saves less than SRMC).

The plant contribution to total GB constraint costs is simply the sum of the costs associated with changing output calculated according to the formulae above. Note that this is done within the optimisation, not as a post-processing step.

[This page is intentionally blank]

ANNEX B – PÖYRY INDEPENDENT MARKET REPORTS

Wind generation data is created using wind reanalysis data (20km x 20km x 10 minutes for all Europe – data provided by Anemos⁸), power curves, hub heights and turbine locations. The data is a refinement (downscaling) of the MERRA reanalysis data which is created using an advanced three-dimensional atmospheric mesoscale model WRF using high-resolution terrain and land-use data. The roughness of the terrain (whether it is forested, farmland or lakes) influences the wind speed across the area. The model also considers elevation information, as the extent to which an area is mountainous, hilly or flat will clearly change the pattern of wind generation. The wind data is benchmarked and comparison with near-surface wind measurements and energy yield data from wind turbines ensures a continuous verification and adaptation to the regional wind climate. For each wind farm, a turbine type (typically based on swept area per MW) and hub height are assumed, with defaults (by zone) for new wind farms and where there is no data available. A power curve is then applied to the wind speeds to get the load factors each hour. A scale factor is applied to the wind speed, partly for wake effects, but also to help match historical load factors. An availability profile is applied to the resulting load factors, covering outages, electrical losses etc.

Solar data is from a 4km solar irradiation atlas of hourly data (provided by Transvalor⁹), combined with an efficiency. This data comes from satellite data (Metosat) which provides cloud cover information, and is combined with Sun-Earth geometry to convert into irradiation data. A similar process to wind is applied to calculate the load factor. The load factor is assumed to be proportional to the irradiation, with the constant of proportionality based both on what is sensible physically (covers temperature and inverter losses etc.) and what gives load factors in line with history.

⁸ www.anemos.de

⁹ www.soda-is.com

[This page is intentionally blank]

ANNEX C – DATA SOURCES

Where possible the public sources for this data are linked. Data sources without a link do not have this included.

Hourly GB demand – <http://www2.nationalgrid.com/UK/Industry-information/Electricity-transmission-operational-data/Data-Explorer/>

GB Demand Split – ETYS 2015

Fuel transportation costs – <http://www2.nationalgrid.com/UK/Industry-information/System-charges/Gas-transmission/Charging-Statements/>

Hourly Interconnector Flows – <http://www2.nationalgrid.com/UK/Industry-information/Electricity-transmission-operational-data/Data-Explorer/>

Wind + Solar generation profiles – Pöyry

Fuel hub prices – Pöyry

Bid/Offer multipliers/adder – National grid Network Economic database (NED)

Year-ahead boundary capabilities – National grid year-ahead outage plan

Zonal generator allocation – FES 2016

[This page is intentionally blank]

QUALITY AND DOCUMENT CONTROL

Quality control

Report's unique identifier: MWE/2017/0746

Role	Name	Date
Author(s):	Ovidiu Stoica (Pöyry) Tomas Poffley (National Grid)	September 2017
Approved by:	James Cox (Pöyry)	September 2017
QC review by:	Matina Delacovias (Pöyry)	September 2017

Pöyry is an international consulting and engineering company.

We deliver smart solutions across power generation, transmission & distribution, forest industry, chemicals & biorefining, mining & metals, transportation and water.

Pöyry PLC has c.5500 experts operating in 40 countries and net sales of EUR 530 million. The company's shares are quoted on Nasdaq Helsinki (POY1V).

Pöyry Management Consulting provides leading-edge consulting and advisory services covering the whole value chain in energy, forest and bio-based industries. Our energy practice is the leading provider of strategic, commercial, regulatory and policy advice to energy markets in Europe, the Middle East and the Americas. Our energy team of 200 specialists, located across 12 offices in 11 countries, offers unparalleled expertise in the rapidly changing energy sector.



Pöyry Management Consulting

King Charles House
Park End Street
Oxford, OX1 1JD
UK

Tel: +44 (0)1865 722660
Fax: +44 (0)1865 722988
www.poyry.co.uk

E-mail: consulting.energy.uk@poyry.com

